

Oznaczenia użyte w ofercie:

A - wysokość mebla

B - szerokość mebla

C - głębokość mebla

W przypadku **stołów i stolików** dodatkowo podana jest informacja dotycząca blatów:

**przykładowo:** 100/12/F/H/G

**lub:** 100 x 70/12/H

gdzie 100 - średnice blatu w cm

lub 100 x 70 - wymiary blatu w cm











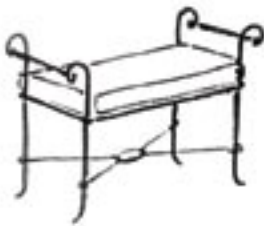
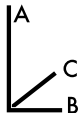
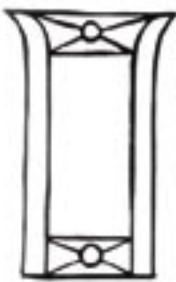
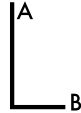

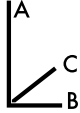
/12/,/15/,/19/ - grubości blatu w mm

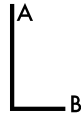

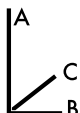
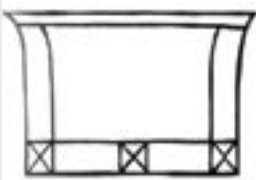

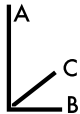
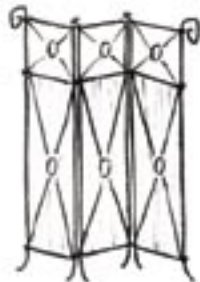
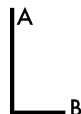

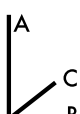

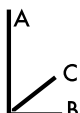



Opcjonalnie:











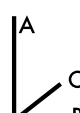
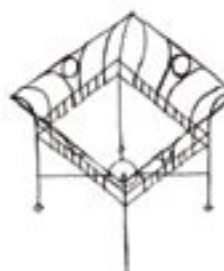
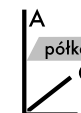

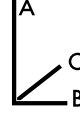
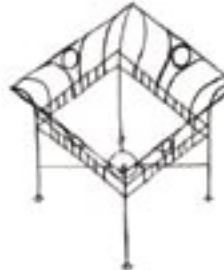
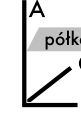
F - faza

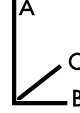
H - hartowany blat

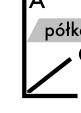
G - grawerowanie

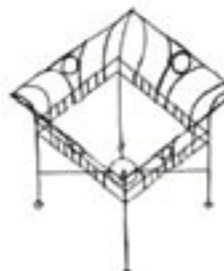
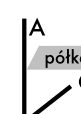
	linia PELEUS produkt-symbol	Wymiary A B C	Cena punkty		linia PELEUS produkt-symbol	Wymiary A B C	Cena punkty
	SZEZŁĄG 110	 A 62 cm B 80 cm C 36 cm	125 pkt* *bez tkanin		LUSTRO 150	 A 130 cm B 60 cm	106 pkt
	KRZESŁO 120	 A 90 cm B 40 cm C 40 cm	132 pkt* *bez tkanin		LUSTRO 151	 A 60 cm B 100 cm	95 pkt
	KRZESŁO 121	 A 90 cm B 55 cm C 52 cm	144 pkt* *bez tkanin		LUSTRO 152	 A 60 cm B 100 cm	76 pkt
	GERYDON 180	 A 75 cm B 30 cm C 30 cm	85 pkt		PARAWAN 170	 A 180 cm B 160 cm	213 pkt
	GERYDON 181	 A 60 cm B 40 cm C 40 cm	95 pkt				
	KONSOLA 140	 A 100 cm B 83 cm C 50 cm	170 pkt				

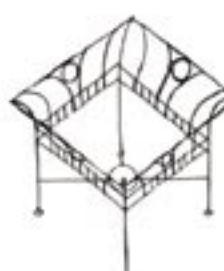
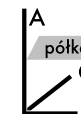
	linia PELEUS produkt-symbol	Wymiary A B C	Cena punkty		linia PELEUS produkt-symbol	Wymiary A B C	Cena punkty
	STÓŁ 130	A 75 cm Ø 120 cm	279 pkt 120/12/F		STOLIK KAWOWY 131	A 52 cm Ø 75 cm	159 pkt 75/10/F
	STÓŁ 130	A 75 cm Ø 120 cm	308 pkt 120/12/G		STOLIK KAWOWY 131	A 52 cm Ø 75 cm	170 pkt 75/10/G
	STÓŁ 130	A 75 cm Ø 120 cm	359 pkt 120/12/H/G		STOLIK KAWOWY 131	A 52 cm Ø 75 cm	180 pkt 75/12/H/G
	STÓŁ 130	A 75 cm Ø 140 cm	350 pkt 140/12/H/F		STOLIK KAWOWY 131	A 52 cm Ø 90 cm	192 pkt 90/12/F
	STÓŁ 130	A 75 cm Ø 140 cm	510 pkt 140/15/H/G		STOLIK KAWOWY 131	A 52 cm Ø 90 cm	224 pkt 90/12/H/G
	STÓŁ 130	A 75 cm Ø 140 cm	558 pkt 140/19/H/G		STOLIK KAWOWY 131	A 52 cm Ø 90 cm	276 pkt 90/15/H/G

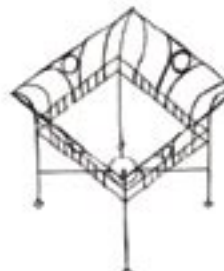
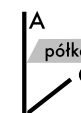
	linia HORUS produkt-symbol	Wymiary A B C	Cena punkty		linia HORUS produkt-symbol	Wymiary A B C	Cena punkty
	KRZESŁO 220	 A 105 cm B 40 cm C 40 cm	128 pkt		STOLIK 230* *blat i półka szklane w każdym modelu	 A 52 cm B 70 cm C 70 cm półka 55,5x55,5 cm	159 pkt 70x70/10
	KRZESŁO 221	 A 105 cm B 40 cm C 40 cm	128 pkt		STOLIK 230*	 A 52 cm B 70 cm C 70 cm półka 55,5x55,5 cm	170 pkt 70x70/10/H
	KRZESŁO 222	 A 105 cm B 40 cm C 40 cm	136 pkt		STOLIK 230*	 A 52 cm B 70 cm C 70 cm półka 55,5x55,5 cm	197pkt 70x70/10/G
	KONSOLA 240	 A 90 cm B 97 cm C 40 cm półka 71x28 cm	180 pkt		STOLIK 230*	 A 52 cm B 90 cm C 90 cm półka 55,5x55,5 cm	203pkt 90x90/12/F
	KONSOLA 241	 A 90 cm B 97 cm C 40 cm półka 71x28 cm	192 pkt		STOLIK 230*	 A 52 cm B 90 cm C 90 cm półka 55,5x55,5 cm	207pkt 90x90/12/G
	KONSOLA 242	 A 90 cm B 97 cm C 40 cm półka 71x28 cm	180 pkt		STOLIK 230*	 A 52 cm B 90 cm C 90 cm półka 55,5x55,5 cm	227pkt 90x90/12/H/G

linia HORUS  
produkt-symbol

Wymiary  
A B C

Cena  
punkty

linia HORUS  
produkt-symbol

Wymiary  
A B C

Cena  
punkty

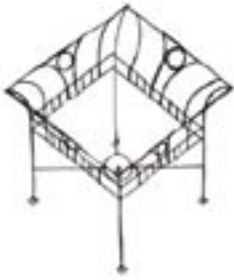

STOLIK  
230\*

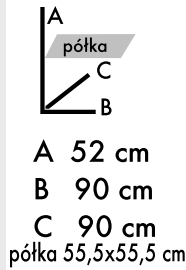

194 pkt  
90x90/15/F



STÓŁ  
233

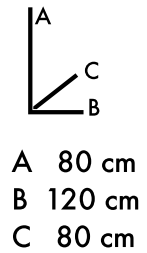

264 pkt  
120x80/12/H/F

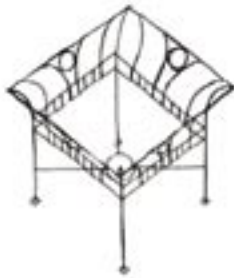

STOLIK  
230\*

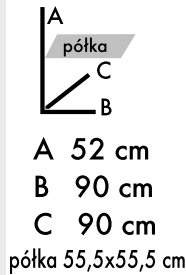

222 pkt  
90x90/15/H/F



STÓŁ  
233

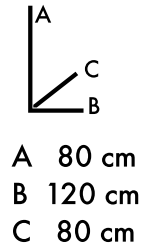

302 pkt  
120x80/12/H/G

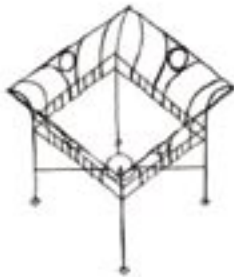

STOLIK  
230\*

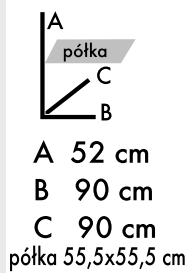

250 pkt  
90x90/15/H/G



STÓŁ  
233

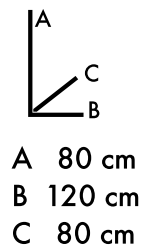

255 pkt  
120x80/12/H

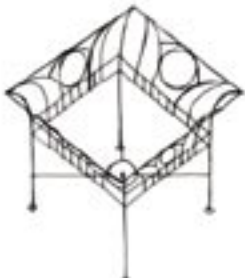

STOLIK  
231\*\*

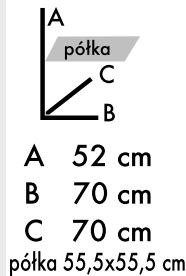

\*\* pkt  
warianty  
i ceny  
jak model  
230



STÓŁ  
233

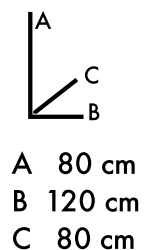

340 pkt  
120x80/15/H/G

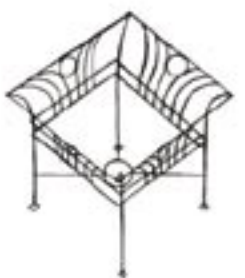

STOLIK  
232\*\*

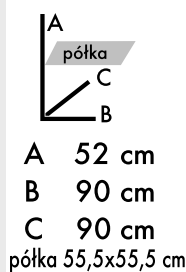

\*\* pkt  
warianty  
i ceny  
jak model  
230



STÓŁ  
233

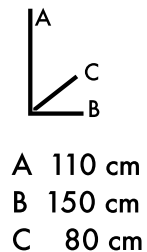

373 pkt  
150x110/15/H



STÓŁ  
233

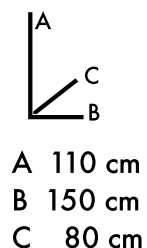

443 pkt  
150x110/15/H/G

linia HORUS  
produkt-symbol

Wymiary  
A B C

Cena  
punkty

linia HORUS  
produkt-symbol

Wymiary  
A B C

Cena  
punkty



STÓŁ  
234

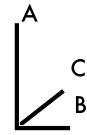

A 80 cm  
B 120 cm  
C 80 cm

360 pkt  
120x80/12/H/G



STÓŁ  
234

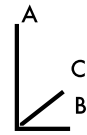

A 80 cm  
B 120 cm  
C 80 cm

310 pkt  
120x80/12/H



STÓŁ  
234

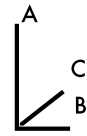

A 80 cm  
B 120 cm  
C 80 cm

390 pkt  
120x80/15/H/G



STÓŁ  
234

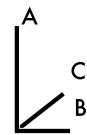

A 110 cm  
B 150 cm  
C 80 cm

490 pkt  
150x110/15/H/G



STÓŁ  
234

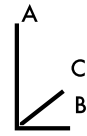

A 110 cm  
B 150 cm  
C 80 cm

420 pkt  
150x110/15/H





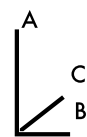







STÓŁ  
234

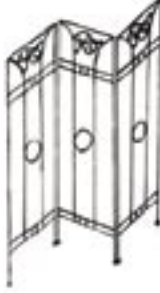

A 110 cm  
B 150 cm  
C 80 cm

442 pkt  
150x110/15/H/F

	linia HORUS produkt-symbol	Wymiary A B C	Cena punkty		linia HORUS produkt-symbol	Wymiary A B C	Cena punkty
	LUSTRO 250	A B A 90 cm B 85 cm	102 pkt		WIESZAK 260	A B A 180 cm B 74 cm	148 pkt
	LUSTRO 251	A B A 90 cm B 85 cm	102 pkt		WIESZAK 261	A B A 180 cm B 74 cm	148 pkt
	LUSTRO 252	A B A 90 cm B 85 cm	102 pkt		WIESZAK 262	A B A 180 cm B 74 cm	148 pkt
	LUSTRO 253	A B A 190 cm B 85 cm	127 pkt		PARAWAN 270	A B A 180 cm B 160 cm	234 pkt
	LUSTRO 254	A B A 190 cm B 85 cm	127 pkt		PARAWAN 271	A B A 180 cm B 160 cm	234 pkt
	LUSTRO 255	A B A 190 cm B 85 cm	127 pkt				

linia EUROPA  
 produkt-symbol

 Wymiary  
 A B C

 Cena  
 punkty

 linia EUROPA  
 produkt-symbol

 Wymiary  
 A B C

 Cena  
 punkty

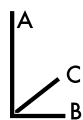
 SZEZŁĄG  
 310

 A 55 cm  
 B 64 cm  
 C 33 cm

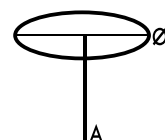
110 pkt

 STÓŁ  
 330

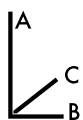
 A 55 cm  
 Ø 100 cm

 210 pkt  
 100/12/F

 KONSOLA  
 340

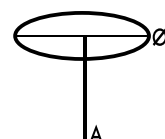
 A 75 cm  
 B 90 cm  
 C 35 cm

149 pkt

 STÓŁ  
 330

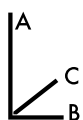
 A 55 cm  
 Ø 100 cm

 234 pkt  
 100/12/H/F

 KONSOLA  
 341

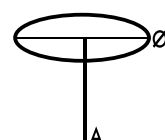
 A 90 cm  
 B 70 cm  
 C 35 cm

149 pkt

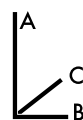

 STÓŁ  
 330

 A 55 cm  
 Ø 110 cm

 258 pkt  
 110/12/H/F

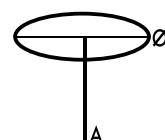
 KONSOLA  
 342

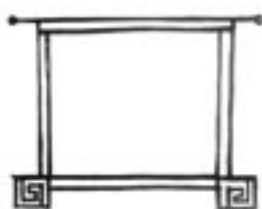
 A 90 cm  
 B 110 cm  
 C 35 cm

191 pkt

 STÓŁ  
 330

 A 55 cm  
 Ø 110 cm

 286 pkt  
 110/12/H/G

 LUSTRO  
 350

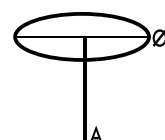
 A 80 cm  
 B 65 cm

68 pkt



 STÓŁ  
 330

 A 55 cm  
 Ø 110 cm

 342 pkt  
 110/15/H/G

 LUSTRO  
 351

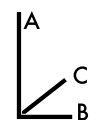
 A 70 cm  
 B 80 cm

89 pkt

 GERYDON  
 380  
 381

 A 60 cm A 75 cm  
 B 40 cm B 25 cm  
 C 40 cm C 25 cm

 53 pkt  
 70 pkt